

◇施工時、主に必要な部材等◇



止水栓



レンチ



温度計



ドライバー



シーリング材



危険：説明書に記載された項目以外は、分解・改造しない
破損して、やけど・けがをしたり、水漏れにより家財などをめらす財
産損害発生のおそれや、水質汚染の可能性があります。



注意：シャワーホースにねじれがないことを確認
破損して、やけど・けがをしたり、水漏れにより家財などをめらす財
産損害発生のおそれの可能性があります。

※交換部品等の情報や、製品に関する最新情報は、ご購入いただきました販売店にお問い合わせください。

1. プレート底部にシーリング材を施して、取付面に挿入してください。

2. スタッドにクランプとワッシャーを差し込み、ナットを締めて取り付けてください。

3. 排水金具のツバの裏側にシーリング材をほどこします。

4. 排水金具を取り付けます。なお、水漏れを防ぐために排水金具のネジ部にはシールテープ等を施してください。

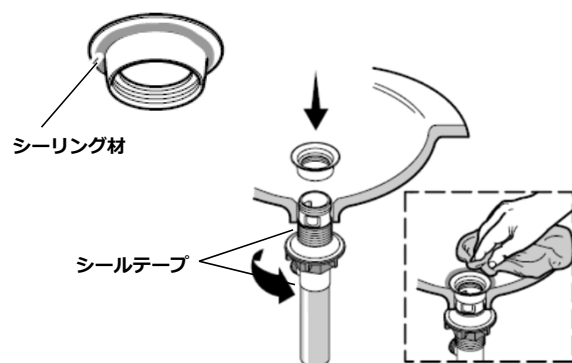
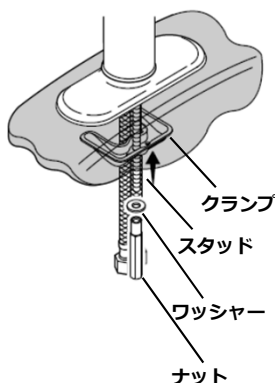
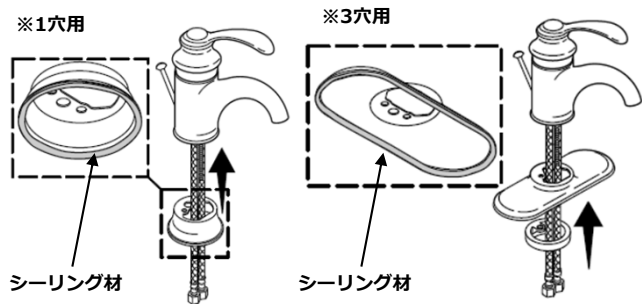

5. ロッドを排水金具に差し込み、取付ナットを締めて取付け、ストッパーを差し込んでください。ロッド上下し、ストッパーの開き具合をストッパーの長さで調整してください。

6. ロッドを最下位置にした状態で、リンクをVクリップで取付け、リックにリフトロッドを差し込んでネジで止めます。

7. 排水金具にトラップを差し込みます。

8. 止水栓と接続します。各接続部分に漏れがないかを確認してください。

9. 泡沫を外し、止水栓を開け、ハンドルを開いて吐水口から1分ほど配管内のごみを流し出した後に、泡沫を吐水口に戻してください。



危険：過度に締め付けない
水漏れにより家財などをめらす財産損害発生のおそれがあります。

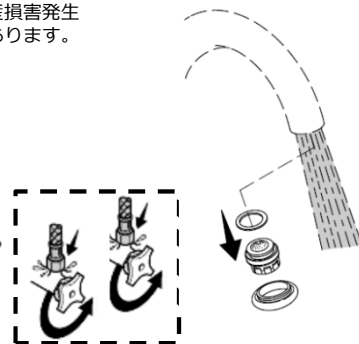
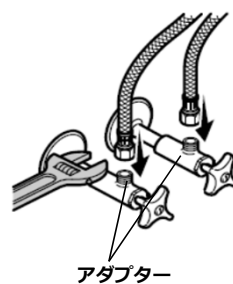
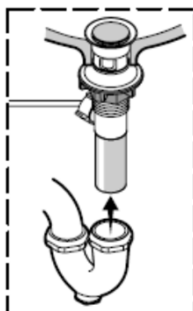
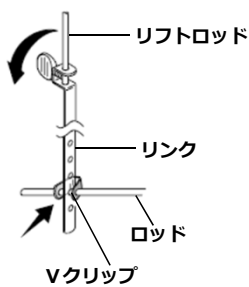
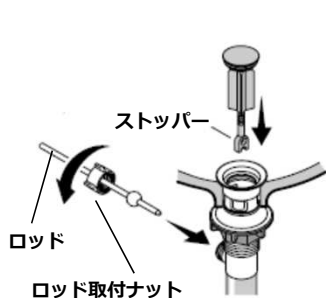

KOHLER® 1 Year Limited Warranty

If a defect is found in normal residential use, Kohler Co. will, at its election, repair, provide a replacement part or product, or make appropriate adjustment.

Damage to a product caused by accident, misuse, or abuse is not covered by this warranty. Improper care and cleaning will void the warranty.

Proof of purchase (original sales receipt) must be provided to Kohler Co. with all warranty claims. Kohler Co. is not responsible for labor charges, installation, or other incidental or consequential costs.

In no event shall the liability of Kohler Co. exceed the purchase price of the faucet.

If the Faucet is used commercially or is installed outside of North America, or if the finish is gold, non-Vibrant or a painted or powder coated color finish, Kohler Co. warrants the Faucet to be free from defects in material and workmanship for 1 year from the date the product is installed, under Kohler Co.'s standard 1 year limited warranty.

If you believe that you have a warranty claim, contact Kohler Co., either through your Dealer, Plumbing Contractor, Home Center or E-tailer.

Please be sure to provide all pertinent information regarding your claim, including a complete description of the problem, the product, model number, color, finish, the date the product was purchased and from whom the product was purchased.

Also include your original invoice.

KOHLER CO. AND/OR SELLER ARE PROVIDING THESE WARRANTIES IN LIEU OF ALL OTHER WARRANTIES, EXPRESSED OR IMPLIED, INCLUDING BUT NOT LIMITED TO THE IMPLIED WARRANTIES OF MERCHANTABILITY AND FITNESS FOR A PARTICULAR PURPOSE.

KOHLER CO. AND/OR SELLER DISCLAIM ALL LIABILITY FOR SPECIAL, INCIDENTAL OR CONSEQUENTIAL DAMAGES.

Some states/provinces do not allow limitations of how long an implied warranty lasts or the exclusion or limitation of such damages, so these limitations and exclusions may not apply to you.

This warranty gives the consumer specific legal rights.

You may also have other rights that vary from state/province to state/province.

This is Kohler Co.'s exclusive written warranty.

Trend® faucets, MasterShower® tower, BodySpa systems and components; WaterHaven® tower, systems and components; Tripoint® faucets, Polished Gold, non-Vibrant and painted or powder coated finishes, fittings; all items within the "Fixture Related" section of the Kohler Faucets Price Book, drains, Duostrainer® sink strainers, soap/lotion dispensers, Moxie™ Wireless Speaker; and faucets used in commercial settings, and outside North America, are covered by Kohler Co.'s one-year limited warranty.

Never use cleaners containing abrasive cleansers, ammonia, bleach, acids, waxes, alcohol, solvents or other products not recommended for chrome. This will void the warranty.....